

EN

ORIGINAL INSTRUCTIONS  
AXIAL FAN



**Table of contents**

Notes regarding the instructions ..... 2

Safety ..... 2

Information about the device ..... 4

Transport and storage ..... 5

Assembly and start-up ..... 5

Operation ..... 6

Available accessories ..... 6

Errors and faults ..... 6

Maintenance ..... 7

Technical annex ..... 8

Disposal ..... 10

Declaration of conformity ..... 10

**Notes regarding the instructions**

**Symbols**

 **Warning of electrical voltage**  
This symbol indicates dangers to the life and health of persons due to electrical voltage.

 **Warning**  
This signal word indicates a hazard with an average risk level which, if not avoided, can result in serious injury or death.

 **Caution**  
This signal word indicates a hazard with a low risk level which, if not avoided, can result in minor or moderate injury.

**Note**  
This signal word indicates important information (e.g. material damage), but does not indicate hazards.

 **Info**  
Information marked with this symbol helps you to carry out your tasks quickly and safely.

 **Follow the manual**  
Information marked with this symbol indicates that the instructions must be observed.

 **Wear hearing protection**  
Information marked with this symbol indicates that you should wear hearing protection.

You can download the current version of the instructions and the EU declaration of conformity via the following link:



TTV 4500 S



<https://hub.trotec.com/?id=42954>

**Safety**

**Read this manual carefully before starting or using the device. Always store the manual in the immediate vicinity of the device or its site of use!**

-  **Warning**  
**Read all safety warnings and all instructions.** Failure to follow the warnings and instructions may result in electric shock, fire and / or serious injury. **Save all warnings and instructions for future reference.**
- This appliance can be used by children aged from 8 years and above and persons with reduced physical, sensory or mental capabilities or lack of experience and knowledge if they have been given supervision or instruction concerning use of the appliance in a safe way and understand the hazards involved. Children shall not play with the appliance. Cleaning and user maintenance shall not be made by children without supervision.
- Do not use the device in potentially explosive rooms.
  - Do not use the device in aggressive atmosphere.
  - Set the device up in an upright and stable position.
  - During normal operation an air transport hose or dust bag can be connected to the air outlet opening.
  - For an increased performance up to 3 devices may be operated in batch mode, i.e. stacked on top of one another during operation. If so, no further accessories such as air transport hose or dust bag must be used.
  - Up to 4 fans can be connected in series by means of the connection pieces.
  - Observe a minimum distance of 3 m between walls, objects and the suction side.
  - Let the device dry out after a wet clean. Do not operate it when wet.
  - Do not use the device with wet or damp hands.
  - Do not expose the device to directly squirting water.
  - Never insert any objects or limbs into the device.
  - Do not cover or transport the device during operation.

- Do not sit on the device.
- This appliance is not a toy! Keep away from children and animals. Do not leave the device unattended during operation.
- Never point the switched-on device at people or animals.
- Check accessories and connection parts for possible damage prior to every use of the device. Do not use any defective devices or device parts.
- Ensure that all electric cables outside of the device are protected from damage (e.g. caused by animals). Never use the device if electric cables or the power connection are damaged!
- The electrical connection must correspond to the specifications in chapter Technical data.
- Insert the mains plug into a properly secured mains socket.
- Observe the technical data when selecting extensions to the power cable. Completely unroll the extension cable. Avoid electrical overload.
- Before carrying out maintenance, care or repair work on the device, remove the mains plug from the mains socket. Hold onto the mains plug while doing so.
- Switch the device off and disconnect the power cable from the mains socket when the device is not in use.
- Do not under any circumstances use the device if you detect damages on the mains plug or power cable. If the supply cord is damaged, it must be replaced by the manufacturer, its service agent or similarly qualified persons in order to avoid a hazard. Defective power cables pose a serious health risk!
- When positioning the device, observe the minimum distances from walls and other objects as well as the storage and operating conditions specified in the Technical data chapter.
- Make sure that the air inlet and outlet are not obstructed.
- Make sure that there are no loose items or dirt located in the immediate surroundings of air inlet and air outlet.
- Protect yourself and your environment from whirled up parts.
- Improper installation can lead to a fire, electric shock or severe personal injury.

### Intended use

The axial fan TTV 4500 S may be used for aeration, deaeration, air circulation, dust collection or air transport whilst adhering to the technical data and the safety instructions.

The device was designed for the generation of a powerful, large-volume air circulation, e.g. for the accelerated drying of buildings and rooms. The fan can be operated in combination with different accessories.

### Improper use

The axial fan TTV 4500 S is not suited for installation in fluids or on flooded or boggy grounds.

Any unauthorised changes, modifications or alterations to the device are forbidden.

### Personal protective equipment



#### Wear hearing protection

Wear appropriate hearing protection when working with the device.

### Personnel qualifications

People who use this device must:

- be aware of the dangers that occur when using high-performance fans.
- have read and understood the instructions, especially the Safety chapter.

### Residual risks



#### Warning of electrical voltage

Work on the electrical components must only be carried out by an authorised specialist company!



#### Warning of electrical voltage

Before any work on the device, remove the mains plug from the mains socket!  
Hold onto the mains plug while pulling the power cable out of the mains socket.



#### Warning

Dangers can occur at the device when it is used by untrained people in an unprofessional or improper way! Observe the personnel qualifications!



#### Warning

The device is not a toy and does not belong in the hands of children.



#### Warning

Risk of suffocation!  
Do not leave the packaging lying around. Children may use it as a dangerous toy.

**⚠ Caution**  
 Risk of injury due to parts being whirled up by the strong air current.  
 Before switching the device on, make sure that there are no loose parts (clothing, hair etc.) located near the air inlet or outlet!

**⚠ Caution**  
 Keep a minimum distance of 3 m to the suction side of the device!

**Note**  
 Do not use abrasive cleaners or solvents to clean the device.

**Behaviour in the event of an emergency**

1. Immediately switch the device off via the main emergency stop switch or the emergency stop at the upstream distributor.
2. Remove persons from the danger area.
3. Disconnect the device from the electric circuit.
4. Do not reconnect a defective device to the mains.

**Information about the device**

**Device description**

The axial fan TTV 4500 S was designed for a very high air flow rate.

The high air volume flow and a variety of configuration options enable its flexible application ranging from construction drying, e.g. in combination with a condenser dryer, to the large-volume air transport even in dusty surroundings.

The cable of this device can be wound around the hose connection. The TTV 4500 S is further equipped with a service socket, which means that you can operate another device, e.g. another TTV 4500 S, in cascaded operation via the same socket. This socket is ready for operation for as long as the first device is connected to the mains – it does not need to be switched on.

The integrated operating hours counter can be used for the settlement with an insurance company or for construction site calculations.

**Device depiction**

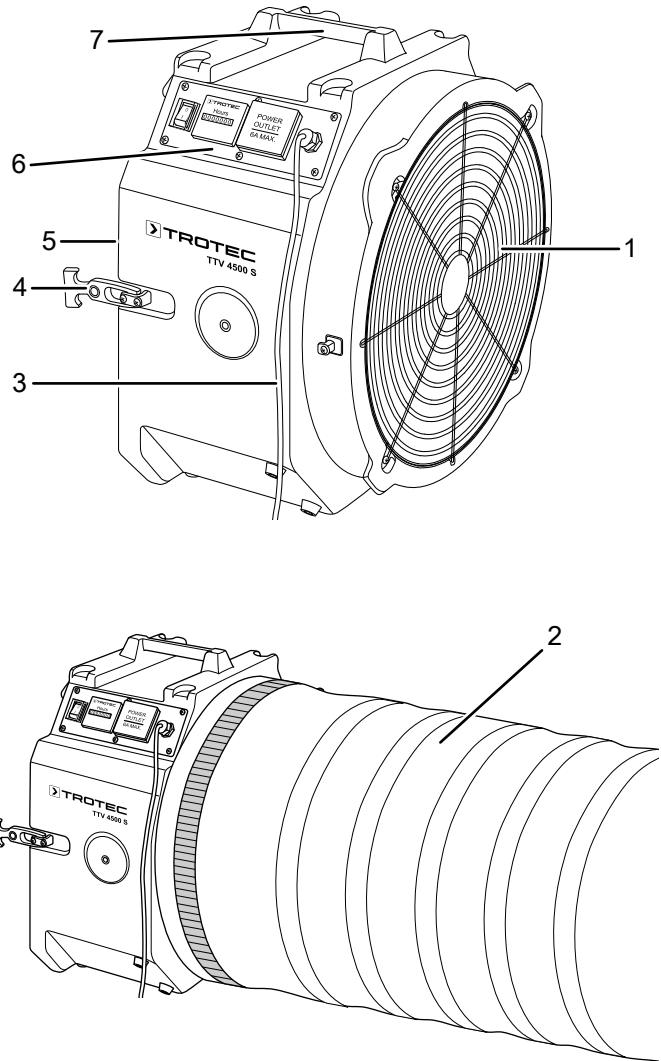

No.	Designation
1	air outlet
2	air hose (optional)
3	mains power cable with Schuko plug
4	connection pieces
5	air inlet
6	control panel
7	transport handle

## Transport and storage

### Note

If you store or transport the device improperly, the device may be damaged.

Note the information regarding transport and storage of the device.

### Transport

To make the device easier to transport, it is fitted with a carry handle.

**Before** transporting the device, observe the following:

- Switch off the device.
- Hold onto the mains plug while pulling the power cable out of the mains socket.
- Do not use the power cable to drag the device.

**After** transporting the device, observe the following:

- Set up the device in an upright position after transport.

### Storage

When the device is not being used, observe the following storage conditions:

- dry and protected from frost and heat
- in an upright position where it is protected from dust and direct sunlight
- with a cover to protect it from invasive dust, if necessary
- stackable: up to 3 devices may be stacked on top of one another



### Info

Do not take the devices into operation when stacked. Stacking rules out an efficient usage of the devices.

## Assembly and start-up

### Scope of delivery

- 1 x Device
- 1 x Manual

### Unpacking the device

1. Open the cardboard box and take the device out.
2. Completely remove the packaging.
3. Fully unwind the power cable. Make sure that the power cable is not damaged and that you do not damage it during unwinding.

### Assembly

1. Assemble the device according to the desired area of application along with other devices or accessories.
  - ⇒ Always use a tension belt to connect hoses or dust bags.

### Start-up

When positioning the device, observe the minimum distance from walls or other objects as described in the Technical data chapter.

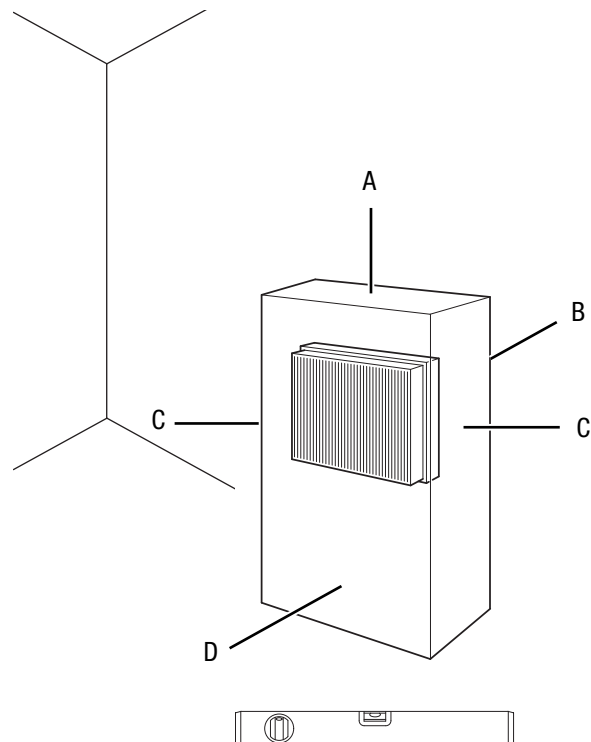

- Set the device up in an upright and stable position. Individually, the axial fan can be installed at an inclination angle of up to 15°.
- Make sure the device is only placed on firm, dry and vibration-free ground.
- When positioning the device, keep a sufficient distance to heat sources.
- Up to four devices can be connected in series for operation.

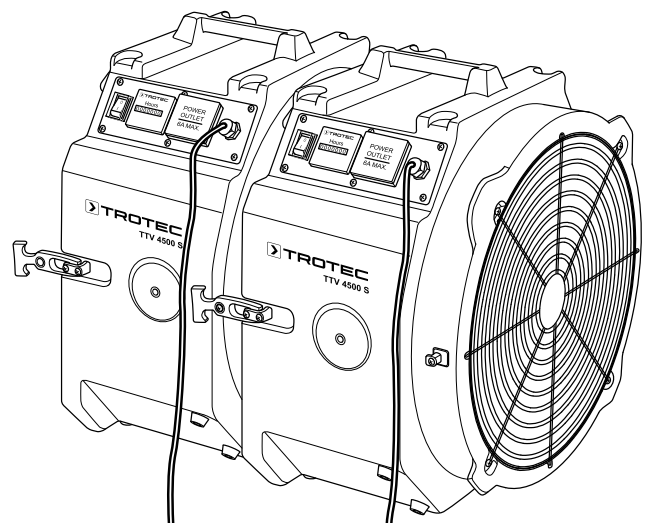

- Make sure that the air inlet and outlet are not obstructed.
- Make sure that extension cables are completely unrolled.

**Connecting the power cable**

- Before restarting the device, check the condition of the power cable. If there are doubts as to the sound condition, contact the customer service.
- Unwind the power cable.
- Insert the mains plug into a properly secured mains socket.

**Operation**

**Operating elements**

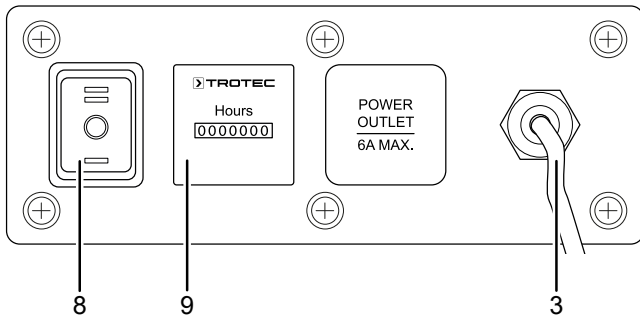

No.	Designation
3	mains power cable
8	on/off step switch I - 0 - II
9	operating hours counter

**Switching the device on**

- ✓ The device has been completely installed as described in the Assembly and start-up chapter.
- 1. Actuate the on/off switch (8) to switch the device on, thus choosing the desired air volume flow level:
  - ⇒ stage I: approx. 4,350 m<sup>3</sup>/h
  - ⇒ stage II: approx. 5,000 m<sup>3</sup>/h

**Shutdown**

-  **Warning of electrical voltage**  
Do not touch the mains plug with wet or damp hands.
- Switch the device off by setting the on/off step switch (8) to position 0.
- Hold onto the mains plug while pulling the power cable out of the mains socket.
- Clean the device according to the Maintenance chapter.
- Store the device according to the Storage chapter.

**Available accessories**

-  **Warning**  
Only use accessories and additional equipment specified in the instructions. Using insertion tools or accessories other than those specified in the instructions may cause a risk of injury.

Designation	Article number
Tilt frame	6.100.005.005
Air transport hose Tronect SP-T, length: 7.6 m	6.100.001.216
Dust bag class M, length: 5 m	7.160.000.112
Universal lashing strap	6.100.001.995

**Errors and faults**

The device has been checked for proper functioning several times during production. If malfunctions occur nonetheless, check the device according to the following list.

**The fan is not running:**

- Check whether the device is switched on.
- Check the power connection.
- Check the power cable and mains plug for damages.
- Check the on-site fusing.

**The fan operates only for a brief period, then switches off:**

- Check whether the protective grid at the air inlet is obstructed in some way. If applicable, remove foreign objects.
- The motor bearing might be damaged. Please contact the customer service.

**The motor or fan is noisy or runs unevenly:**

- The fan is soiled. Clean the fan according to the Maintenance chapter.
- The fan or the blower unit is damaged. Please contact the customer service. If necessary, bring the device to an authorized specialist electrical company or to Trotec for repair.
- The motor bearing might be damaged. Please contact the customer service. If necessary, bring the device to an authorized specialist electrical company or to Trotec for repair.

**The fan produces grinding noises:**

- The fan blades are dirty or foreign objects are located in the rotation range of the fan. Clean the fan blades or the blower unit according to the Maintenance chapter.
- The fan blades might be damaged. Please contact the customer service. If necessary, bring the device to an authorized specialist electrical company or to Trotec for repair.

### The device vibrates heavily:

- Check the floor space of the fan. Position the device on a level and firm surface.
- Check the screwed connections, particularly between blower unit and foot. If necessary, retighten the screws.
- Check the fan blades for dirt and clean them if required.
- There might be an imbalance in the fan blades. Please contact the customer service. If necessary, bring the device to an authorized specialist electrical company or to Trotec for repair.

### The air flow rate is low:

- Check whether the protective grid is blocked and clean it if required.

#### Note

Wait for at least 3 minutes after maintenance and repair work. Only then switch the device back on.

### Your device still does not operate correctly after these checks?

Please contact the customer service. If necessary, bring the device to an authorized specialist electrical company or to Trotec for repair.

## Maintenance

### Activities required before starting maintenance



#### Warning of electrical voltage

Do not touch the mains plug with wet or damp hands.

- Switch the device off.
- Always be mindful of atypical sounds and consult a specialist dealer if in doubt.
- Hold onto the mains plug while pulling the power cable out of the mains socket.



#### Warning of electrical voltage

**Tasks which require the housing to be opened must only be carried out by authorised specialist companies or by Trotec.**

### Cleaning the housing

Clean the housing with a soft, damp and lint-free cloth. Make sure that no moisture enters the housing. Protect electrical components from moisture. Do not use any aggressive cleaning agents such as cleaning sprays, solvents, alcohol-based or abrasive cleaners to dampen the cloth.

### Cleaning the fan and device interior



#### Warning

Risk of injury caused by ejected compressed air upon activation of the compressed air supply.

Hold the compressed-air hose away from your body. Pointing the compressed-air hose at another person is prohibited.

- Check fan and protective grid for perfect condition before and after each application.
- Clean the fan after each operation.
- Use compressed air to remove particles, lint, dust and dirt from motor, fan wheel and protective grid. Do not in any event use a high-pressure cleaner to clean the fan.
- Regularly check the housing for its perfect condition or for defects.
- Other than that, the device does not require maintenance.

**Technical annex**

**Technical data**

Parameter	Value
<b>Model</b>	TTV 4500 S
Article number	1.510.000.013
Air volume stage 1	approx. 4,350 m <sup>3</sup> /h
Air volume stage 2	approx. 5,000 m <sup>3</sup> /h
Air pressure	130 Pa
Max. sound level (at a distance of 3 m)	74 dB(A)
Air current	blowing out / sucking in
Air discharge velocity	11 m/s (39.6 km/h)
Mains connection	1/N/PE~ 230 V / 50 Hz
Current consumption	1.7 A
Power input	0.33 kW
Fusing	10 A
Transport medium temperature	45 °C
Hose connector	480 mm Ø
Type of protection	IP 44
Housing	plastic
Mobility	portable / stackable
Weight	15 kg
Minimum distance to walls and other objects	0.5 m 3 m top (A): 0.5 m rear / suction side (B): 0.5 m sides (C): front (D):
Dimensions (length x width x depth)	330 x 530 x 560 mm

**Circuit diagram**

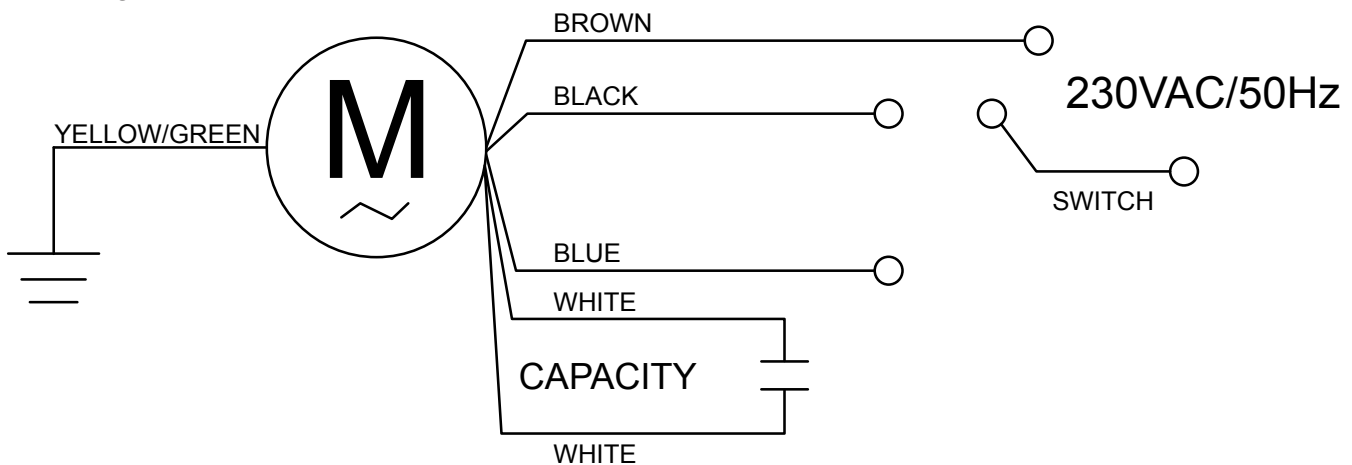



## Overview and list of spare parts

### Note!

The position numbers of the spare parts differ from those describing the positions of other parts mentioned in this operating manual.

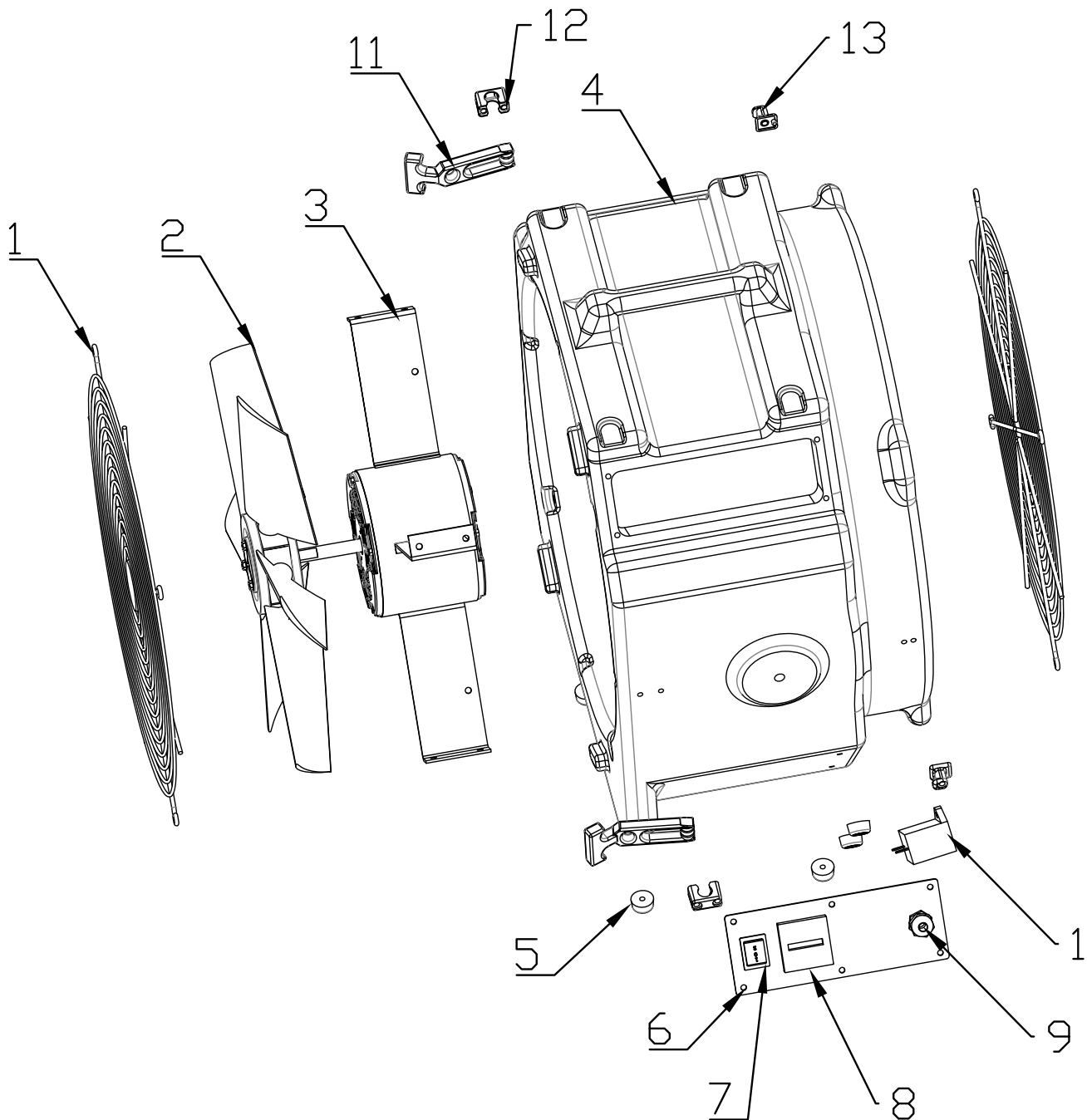

No.	Spare part	Qty.
1	Metal Grill	2
2	Fan Blade	1
3	Motor	1
4	Plastic Housing	1
5	Rubber	12
6	Switch Panel	1
7	Switch	1

No.	Spare part	Qty.
8	Mechanical Timer	1
9	Wire Connector	1
10	Capacitor	1
11	Rubber Connector	1
12	Rubber Fix	1
13	Rubber Nail	1
14	Power Cord	1

## Disposal



The icon with the crossed-out waste bin on waste electrical or electronic equipment stipulates that this equipment must not be disposed of with the household waste at the end of its life. You will find collection points for free return of waste electrical and electronic equipment in your vicinity. The addresses can be obtained from your municipality or local administration. For further return options provided by us please refer to our website [www.trotec24.com](http://www.trotec24.com).

The separate collection of waste electrical and electronic equipment aims to enable the re-use, recycling and other forms of recovery of waste equipment as well as to prevent negative effects for the environment and human health caused by the disposal of hazardous substances potentially contained in the equipment.

## Declaration of conformity

The text below sets out the contents of the declaration of conformity. The signed declaration of conformity can be found at <https://hub.trotec.com/?id=42954>.

### Declaration of conformity

in accordance with the EC Machinery Directive 2006/42/EC, Annex II, Part 1, Section A

Herewith, we – Trotec GmbH – declare that the machinery designated below was developed, constructed and produced in compliance with the requirements of the EC Machinery Directive in the version 2006/42/EC.

**Product model / Product:** TTV 4500 S

**Product type:** axial fan

**Year of manufacture as of:** 2019

### Relevant EU directives:

- 2014/30/EU: 29 March 2014
- 2014/35/EU: 8 September 2017

### Applied harmonised standards:

- EN 55014-1:2006/A1:2009
- EN 55014-1:2006/A2:2011
- EN 55014-2:1997/A1:2001
- EN 55014-2:1997/A2:2008
- EN 61000-3-2:2014
- EN 61000-3-3:2013

### Applied national standards and technical specifications:

- EN 61000-4-2:2009
- EN 61000-4-4:2012
- EN 61000-4-5:2006
- EN 61000-4-6:2014
- EN 61000-4-11:2004

### Manufacturer and name of the authorised representative of the technical documentation:

Trotec GmbH  
Grebener Straße 7, D-52525 Heinsberg  
Phone: +49 2452 962-400  
E-mail: [info@trotec.de](mailto:info@trotec.de)

Place and date of issue:

Heinsberg, 12.05.2014

Detlef von der Lieck, Managing Director

Trotec GmbH

Grebener Str. 7  
D-52525 Heinsberg

☎ +49 2452 962-400

☎ +49 2452 962-200

✉ [info@trotec.com](mailto:info@trotec.com)

[www.trotec.com](http://www.trotec.com)